

# masibus®

A Sonepar Company



## Controller & Indicator





# Overview of Process Controllers

## What is a Controller?

A Controller is a device that is used to control an equipment by comparing a process signal with a set point and performing calculations according to the deviation between those values. Devices that can handle process signals such as Temperature, Humidity, Pressure and Flow Rate are called Controllers.

ON/OFF Controller

Types of  
Process  
Controllers

PID Controller

## Difference between ON/OFF and PID Controller

- PID Controller can provide output in both the form, Analog and Digital, whereas an ON/OFF controller provides output in digital form only
- ON/OFF Controllers are used in applications where some deviation can be accepted without hampering the process., whereas PID Controllers are used in applications where a very less amount of deviation is accepted
- In ON-OFF control method process can not be stable at set-point and the PID controller can adjust its output to match the power that is required to keep the process stable at the setpoint
- PID Controllers are costlier than ON/OFF Controllers, due to more features that they provide and the precision with which PID controllers operates



# Overview of Controllers

## Controller Configuration of a Feedback Control System

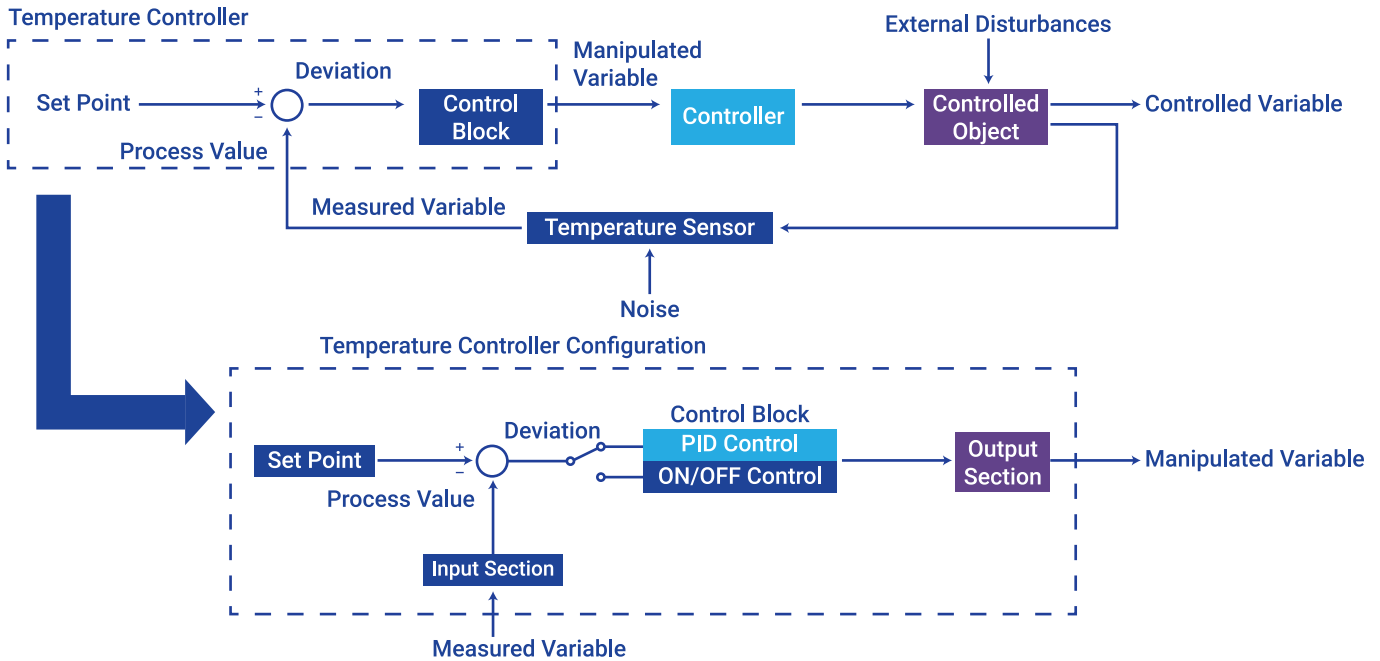

## Control Methods

### What is ON/OFF Control Action?

ON/OFF Controller is the simplest form of temperature control device. The output from the device is either ON or OFF, with no middle state. An ON/OFF Controller will switch the output only when the temperature crosses the set point.

For ex.: For heating control, the output is ON when the temp. is below the set point, and OFF above set point.

Characteristics of ON/OFF Control Action



### What is PID Control Action?

A PID Controller is an instrument used by control engineers to regulate temperature, flow, pressure, speed and other process variables in industrial control systems. PID controllers use a control loop feedback mechanism to control process variables and are the most accurate and stable controller.

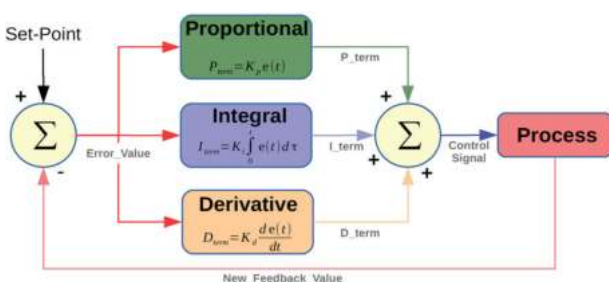

PID control is a well-established way of driving a system towards a target position or control parameters. It's practically ubiquitous as a means of controlling temperature and finds application in a myriad of chemical and scientific processes as well as automation. PID control keeps the actual output from a process as close to the target or setpoint output as possible.



# Overview of Controllers

## PID Controller Working Principle

The working principle behind a PID Controller is that the proportional (“P”), integral (“I”), and derivative (“D”) terms must be individually adjusted or ‘tuned’. Based on the difference between these values a correction factor is calculated and applied to the input.

**For example:** If an oven is cooler than required, the heat will be increased.

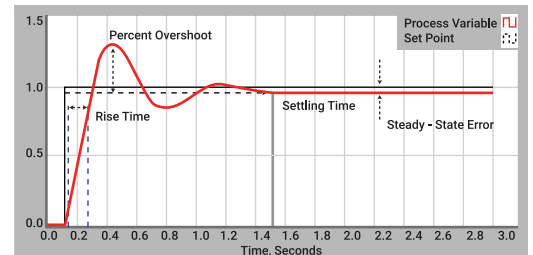

## Here are the three steps

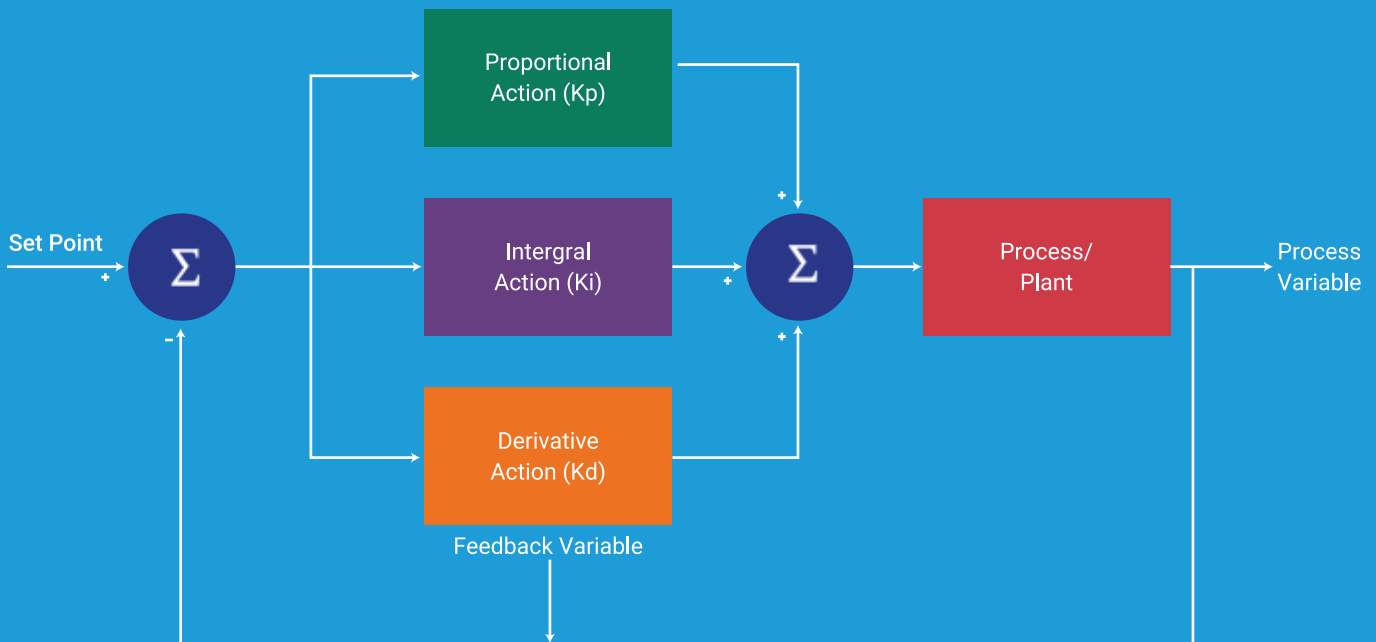

- **Proportional Tuning** involves correcting a target proportional to the difference. Thus, the target value is never achieved because as the difference approaches zero, so does the applied correction
- **Integral Tuning** attempts to remedy this by effectively cumulating the error result from the “P” action to increase the correction factor. **For example:** If the oven remained below temperature, “I” would act to increase the heat delivered. However, rather than stop heating when target is reached, “I” attempts to drive the cumulative error to zero, resulting in an overshoot
- **Derivative Tuning** attempts to minimize this overshoot by slowing the correction factor applied as the target is approached.





# Controllers Offerings



TC5396



TC548E



TC548



TC596



LC5296V-AT



5040



5002U-P



5006-RN



LC5296-DC



LC5296-AT



LC5296-XP-DC



LC5296-XP-AT



**Experience:** 45+ years of experience in designing controllers

**Fail Safe:** Designed to go in safe mode when process fails



**Knowledge:** Backed by vast application knowledge for Industries

**Communication:** Easy to manage and interface with PLC, SCADA and IloT









**Configurable:** Input & output signal type is configurable, helps reduce inventory

**Service:** Rugged, Reliable & Repeatable Controller with 10 years service support





## Technical Specifications- Controllers

		5040	5040-XP	5002U-P	LC5296-AT	LC5296L-AT	LC5296-XP-AT	LC5296-DC
								
Mounting		Panel	Wall	Panel	Panel	Panel	Wall	Panel
Panel Cut Out (HXW)		92.5 x 92.5	-	92.5 x 92.5	92.5 x 92.5	92.5 x 92.5		92.5 x 92.5
Dimension (HXWXD)		96 x 96 x 110	340 x 186 x 165	96 x 96 x 110	96 x 96 x 75	96 x 96 x 75	340 x 186 x 110	96 x 96 x 75
Character Height	PV	0.56"	0.56"	0.56"	0.56"	0.56"	0.56"/0.8"	0.56"
	SV	0.4"	0.4"	0.4"	0.4"	0.4"	0.4"/0.56"	0.56"
Accuracy	TC, RTD	± 0.1% of F.S ± 1° C	± 0.1% of F.S ± 1° C	TC (E,J,K,T,C,J,N,C,G), RTD: ± 0.1% of F.S ± 1° C	±0.25% of FS ±1 count	±0.25% of FS ±1 count	±0.25% of FS ±1 count	±0.25% of FS ±1 count
	TC (B,R,S)			: ± 0.2% of F.S ± 1° C				
	Current, Voltage	± 0.1% of F.S ± 1 count	± 0.1% of F.S ± 1 count	± 0.1% of F.S ± 1 count	± 0.1% of F.S ± 1 count	± 0.1% of F.S ± 1 count	± 0.1% of F.S ± 1 count	± 0.1% of F.S ± 1 count
Input	Process Value Input	Thermocouple (E, J, K, T, B, R, S, N) RTD (Pt100), Current, Voltage	Thermocouple (E, J, K, T, B, R, S, N) RTD (Pt100), Current, Voltage	Thermocouple (E, J, K, T, B, R, S, N, C, G) RTD (Pt 100), Current, Voltage	Thermocouple (E, J, K, T, B, R, S), RTD (Pt100), Current, Voltage	Thermocouple (E, J, K, T, B, R, S), RTD (Pt100), Current, Voltage	Thermocouple (E, J, K, T, B, R, S), RTD (Pt100), Current, Voltage	Thermocouple (E, J, K, T, B, R, S), RTD (Pt100), Current, Voltage
	Remote Setpoint Input	4 to 20 mA, 0-20mA, 0-5V, 1-5V	4 to 20 mA, 0-20mA, 0-5V, 1-5V	X	X	X	X	X
	ZV Input	Potentiometer 100 to 2K Ohm	Potentiometer 100 to 2K Ohm	X	X	X	X	X
	Digital Input	4	4	X	X	X	X	X
Control Output	Relay	●	●	●	●	●	●	●
	SSR	●	●	X	●	●	●	X
	Linear	●	●	X	●	X	●	X
	Motorized Valve	●	●	X	●	X	●	X
Output	Re-transmission Output	Upto 2*	Upto 2*	Upto 2*	Upto 2*	X	Upto 2*	Upto 2*
	Alarm	Upto 4 *	Upto 4 *	3	Upto 2*	Upto 2*	Upto 2*	Upto 2*
	Digital Output	4	4	X	X	X	X	X
	LPS	●	●	●	●	X	●	●
Control Method	ON/OFF	●	●	●	●	●	●	●
	PID	●	●	X	●	●	●	X
Communication	RS-485	●	●	●	●	X	●	●
Power Supply	85-265 VAC / 100-300 VDC	●	●	●	●	●	●	●
	18-36 VDC	●	●	●	●	●	●	●

\* For more details, refer Product Catalogue





# PID Controllers

## 5040 Single Loop PID Controller



5040

5040-XP

- User friendly menu driven hardware and software configuration
- Truly universal Input / Output including valve positioner
- One model for all applications, reduces inventory
- Field proven for critical Ratio/Cascade applications
  - Right fit for combustion control
- Favourite page selection for frequently used parameter
- 4 Digital input and 4 digital output options available

## Pulp Consistency Control- Paper Industries

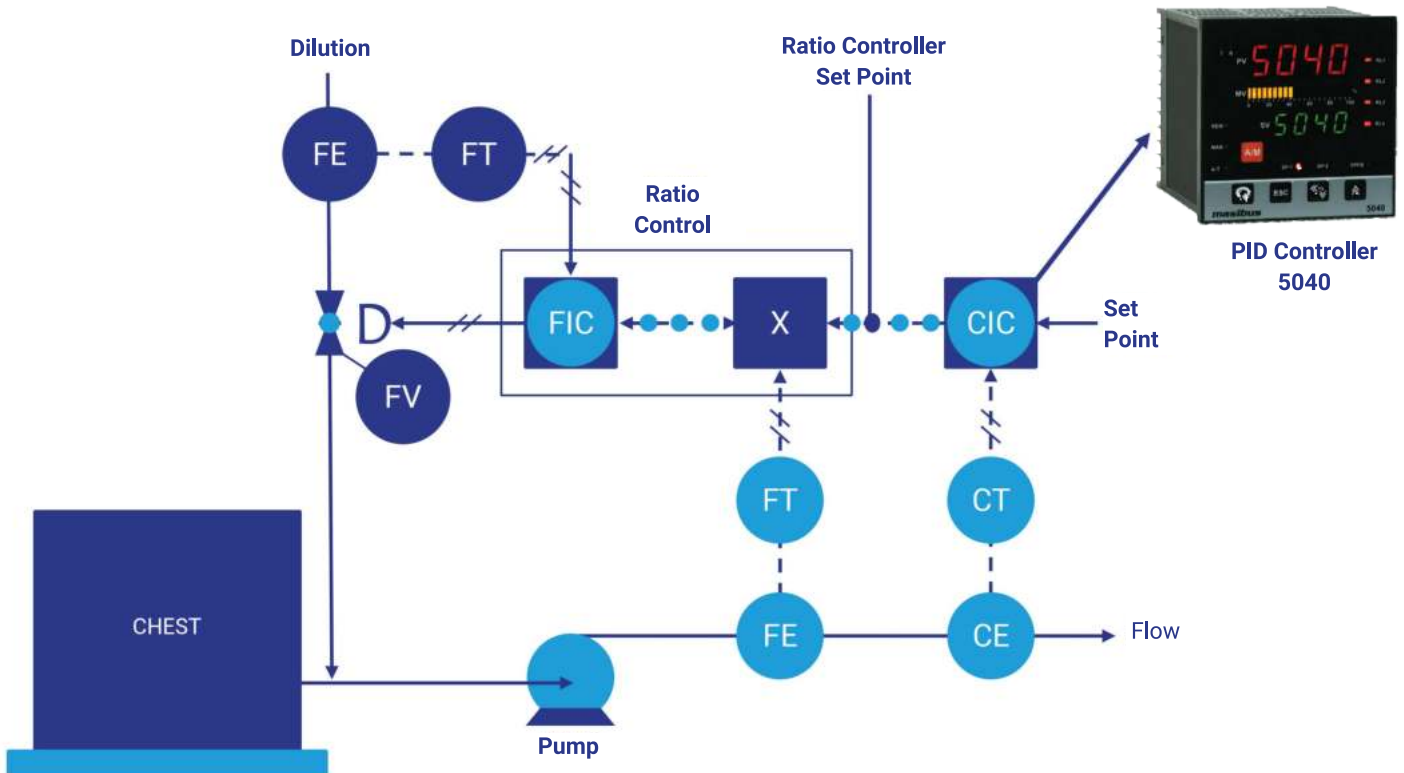

## Boiler Suction Control- Power Plant





# 5040 Single Loop PID Controller Applications

## Cascade Control

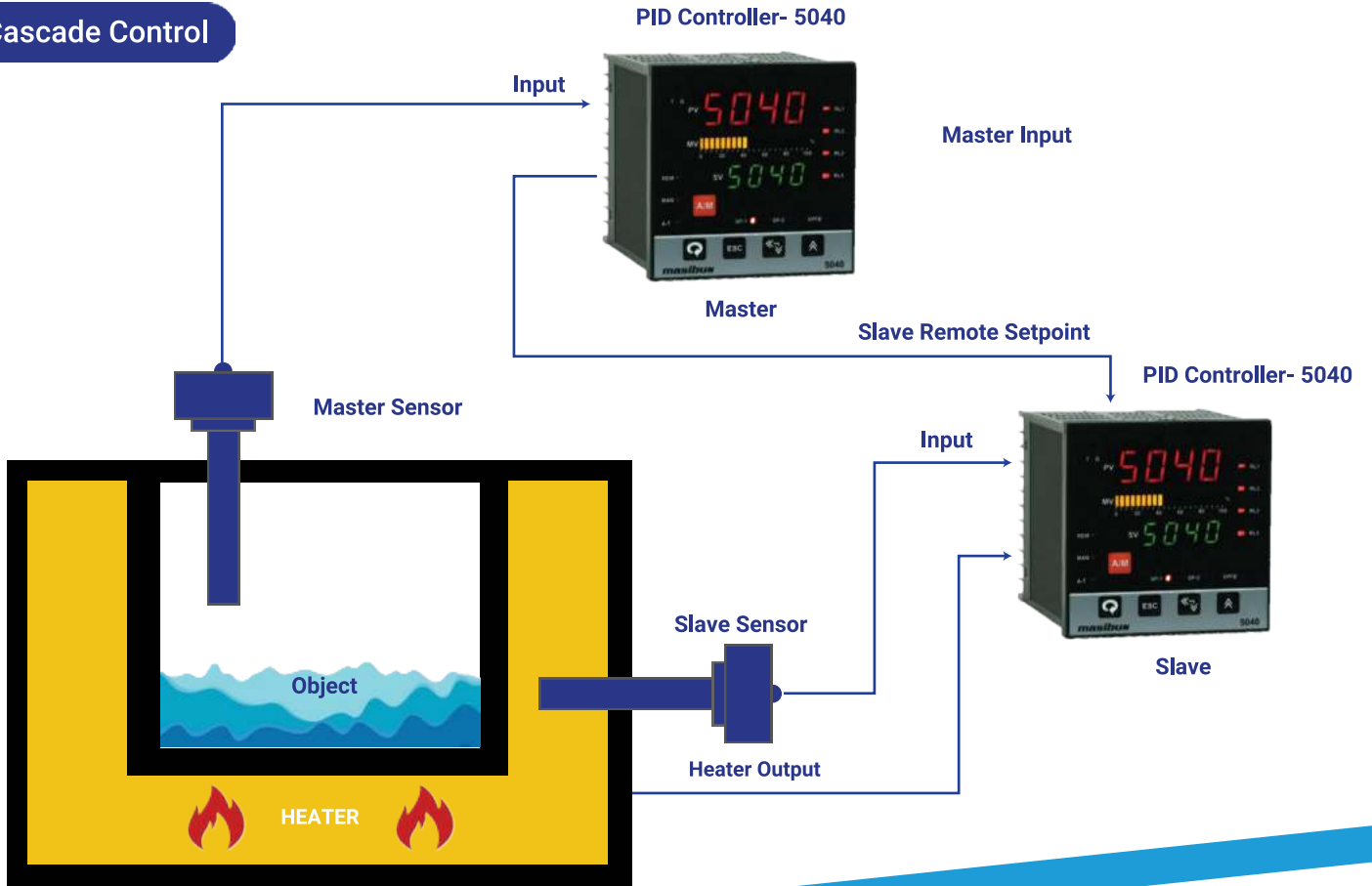

## Ratio Control

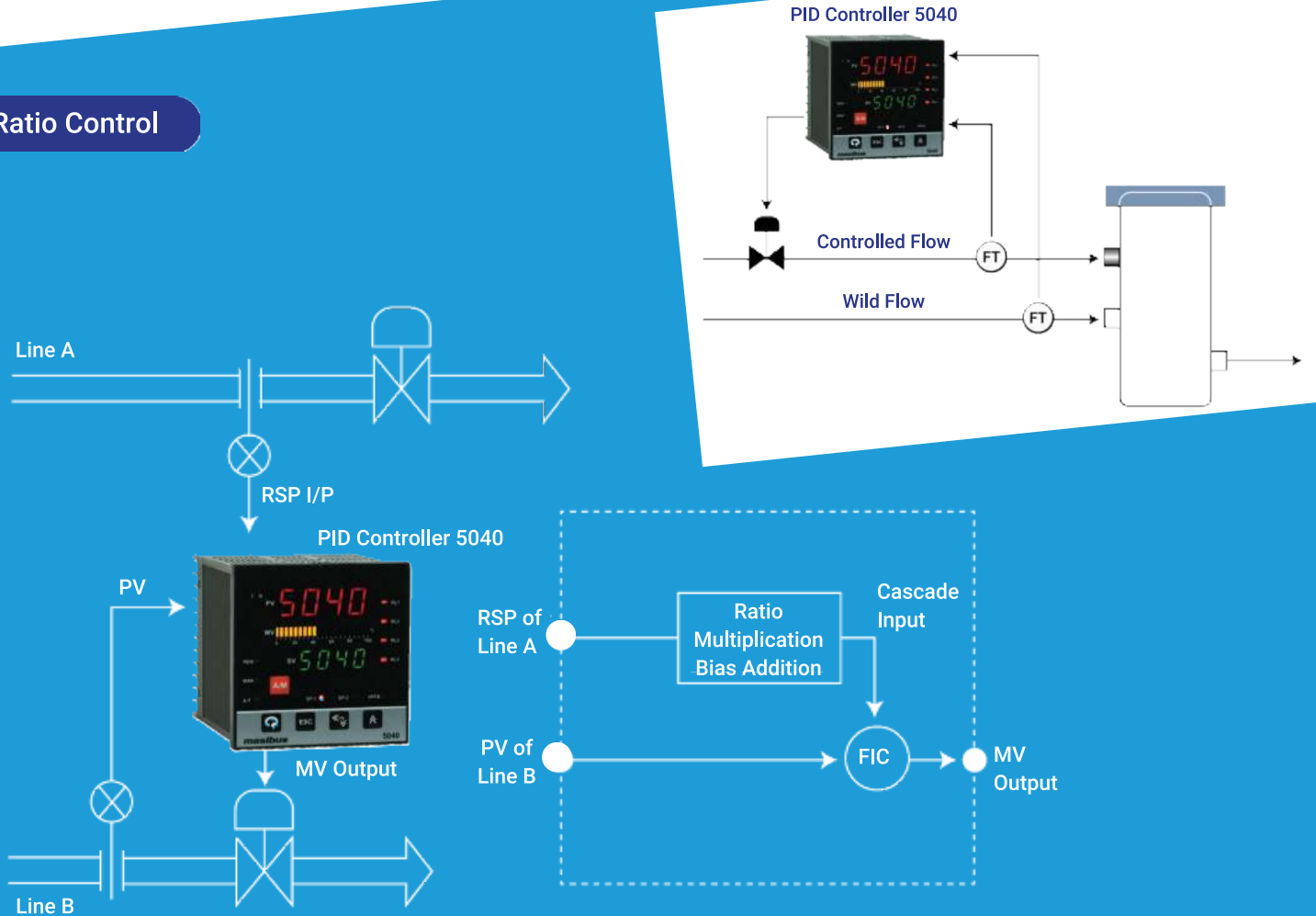





# PID & ON/OFF Controllers

## LC5296-XP-AT/ LC5296-XP-DC- Flame Proof PID & Dual Channel ON/OFF Controller



LC5296-XP-DC

LC5296-XP-AT

- CMRI and CCOE certifications complies to all statutory requirements of hazardous locations group IIA, IIB & IIC
- Touch sensitive keys operation and programming
  - Dual compartment option for Re-transmission (Field Prog.) and/or RS-485 add-on options
- 2 x Isolated Retransmission- Saves additional signal isolator requirement
- TPS with current limit- Saves external TPS, provides isolation and protection
- The configuration meets all ON/OFF and PID applications in hazardous areas
- Multitude of alarm types meets most critical applications

## 5002U-P ON/OFF Controller

- Simple user interface- Preferred in processes like heat treatment, ideal for metal treatment applications
- Fail safe: Protects process in case of failure
- Four relay for control and alarm, Re-transmission and RS-485 comm. to interface PLC/DCS and remote monitoring system
- Field proven in harsh environments
- Up to 4 independent programmable relay output



5002U-P

## PID and ON/OFF Controller- LC5296-AT | LC5296V-AT | 5006RN | TC5396 | TC548E



LC5296-AT



LC5296-V-AT



5006-RN



TC5396



TC548E

- Advanced, Efficient & Economical PID Controller
  - Large and bright display
- 4 Relay/2 relay/SSR output for control / alarm / trip
  - Retransmission field programmable and/or RS-485 add-on options
- 2 X Isolated Re-transmission (Optional)
- Saves additional signal isolator requirement
  - TPS with current limit
- Features, options and configurability meets 80% of PID applications
  - Highest performance / price ratio



# TC5396 PID and ON/OFF Controller Applications

## Temperature Control for Seal Heating Parts in Wrapping Machinery

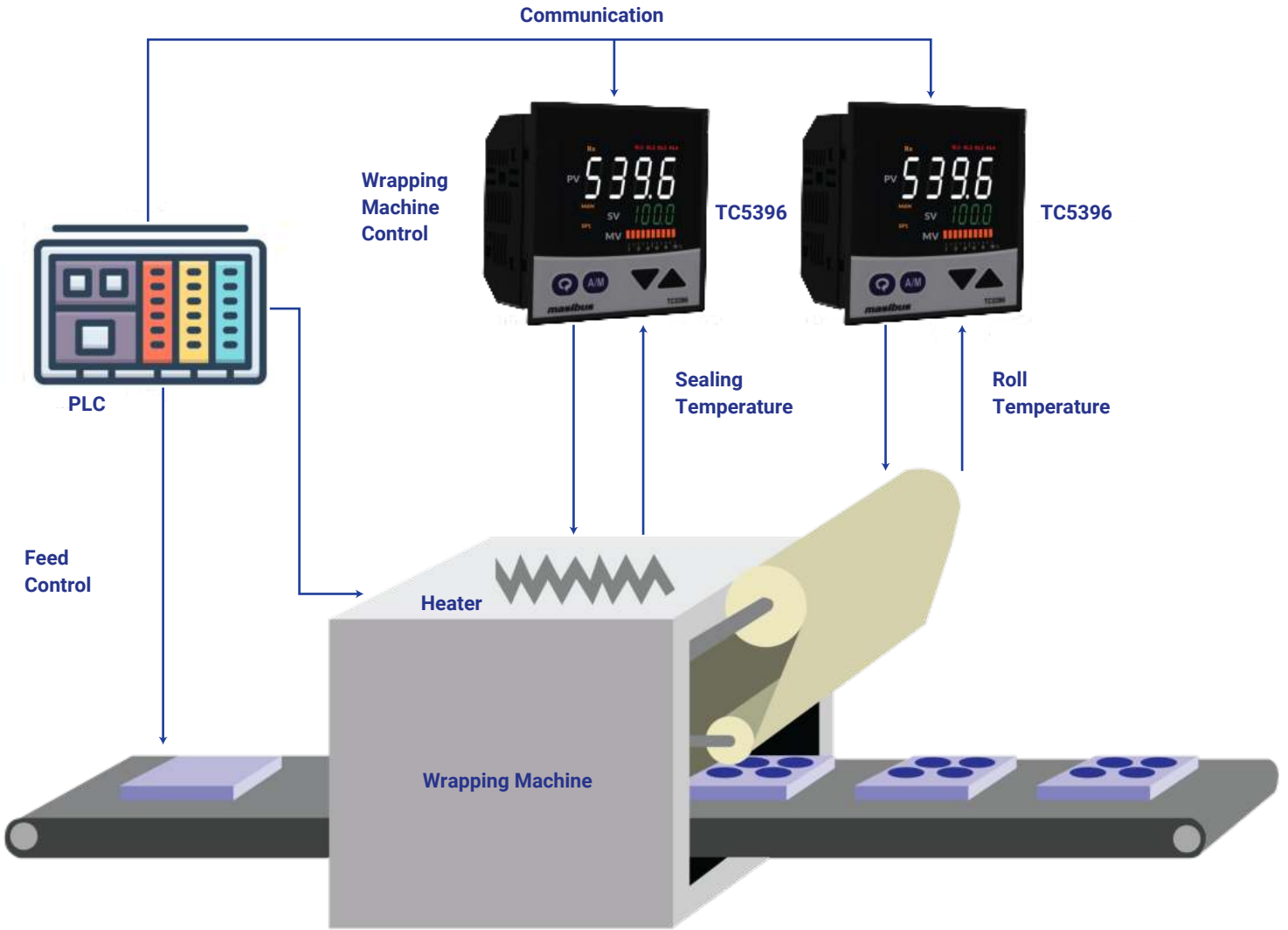

## Furnace Monitoring

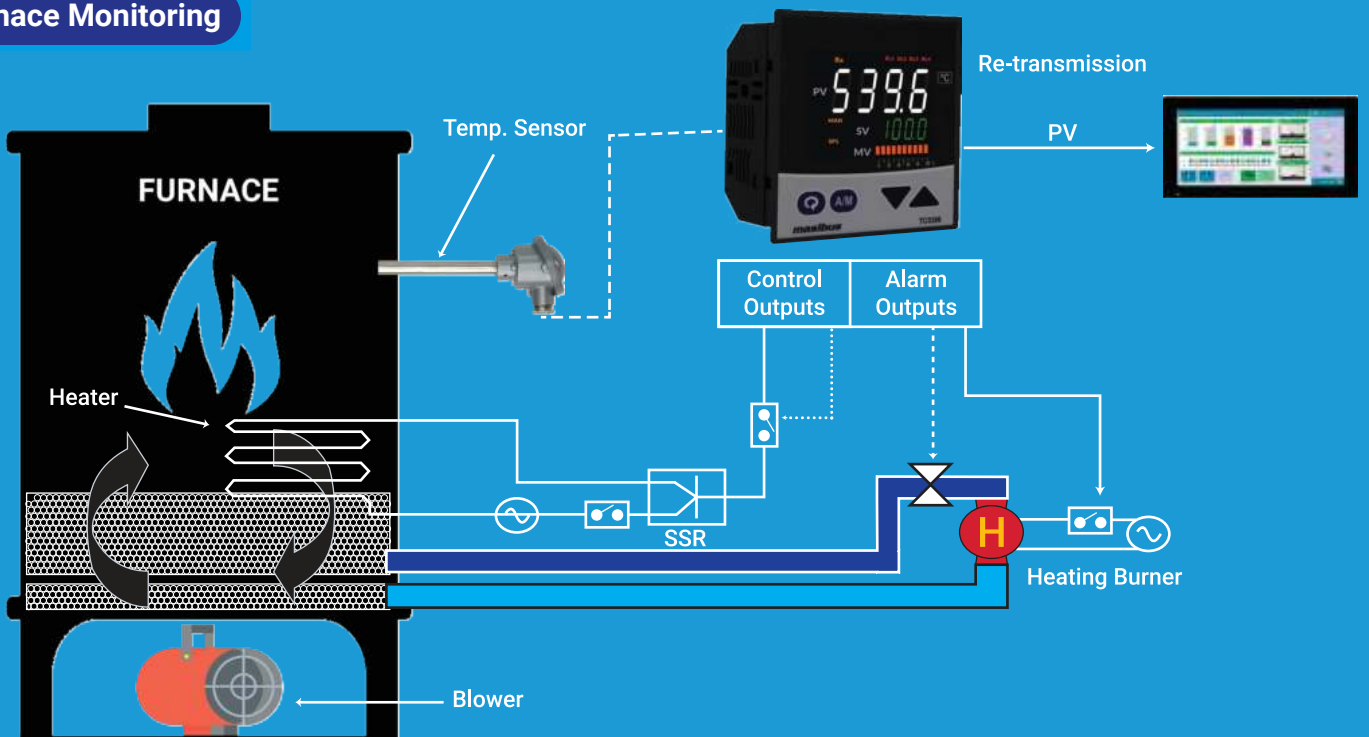



# TC548 & TC548E PID and ON/OFF Controller Applications

## PID Controller Extruder Machine Applications



TC548E  
PID-ON/OFF Controller

## Belling / Socketing Machine / Cutting Sealing Machine

TC548  
PID-ON/OFF Controller

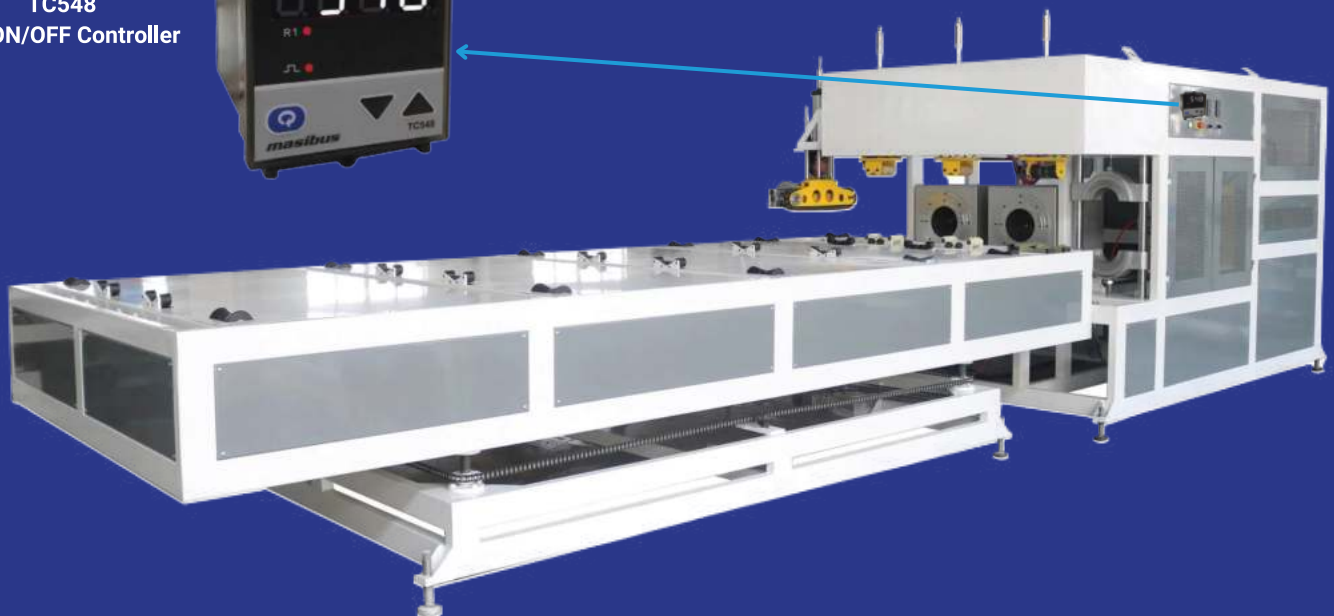



# Controller Applications

## Furnace Temperature Controller



5002U-P



Sealed Quench Furnace

## Compressor Coolant Temperature Controller



TC548E  
PID-ON/OFF Controller





# Overview of Indicator Offerings

## What is a Digital Panel Indicator

Digital panel indicator receives the measurement signal as Input in the form of Voltage / Current / RT / TC / Humidity / Pressure / Flow Rate / Level / Load Cell / pH / Pulses / mV etc., process it and displays after necessary scaling/linearization which is configurable from keypad / touch-pad.

They can also act as interfaces by performing operations such as comparisons with user-set values, and transmitting data to computers / PLC / DCS.

Masibus Indicators are easy to use and have good visibility in the field with wide variety of display size 0.3" / 0.56" / 2" / 4" / 6" and no. of digits 4 / 5 / 6.

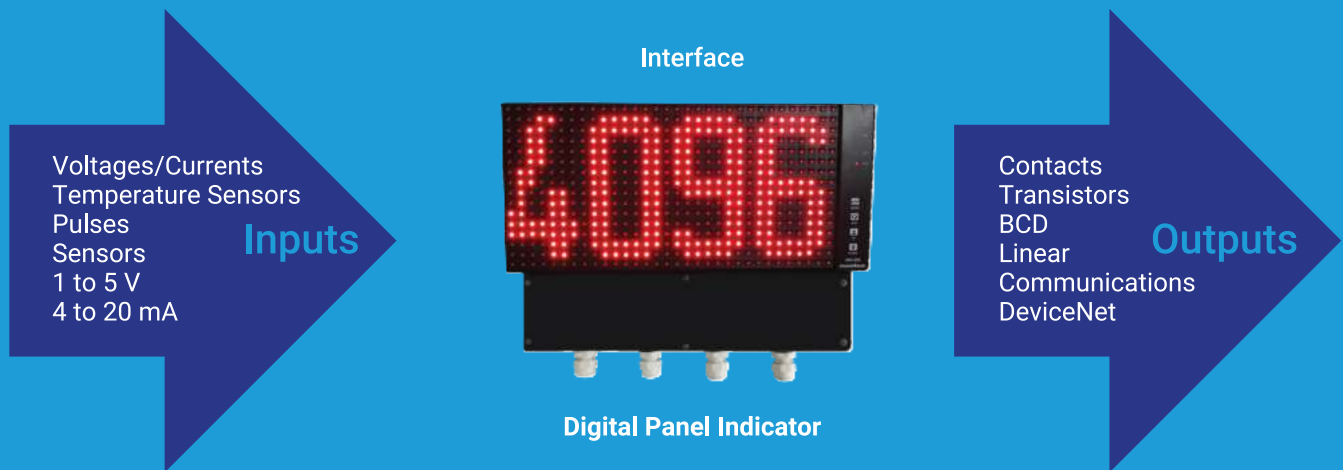

## Indicator with Alarm and Trip

Indicator monitors a process signal (such as one representing temperature, pressure, level or flow) and compares it against a preset limit. If the process signal moves to an undesirable high or low condition, the alarm activates a relay output which could be utilized for alarm declaration, maintain a normal & safe operation.

In all our Indicators we have separate relay output for alarm and trip condition.

Once a signal crosses the alarm condition, alarm relay gets activated. On reaching trip condition, trip relay gets activated. Both output could be latched by the initial configuration of the indicators (For selected models).

The latching could be made reset by acknowledgment.

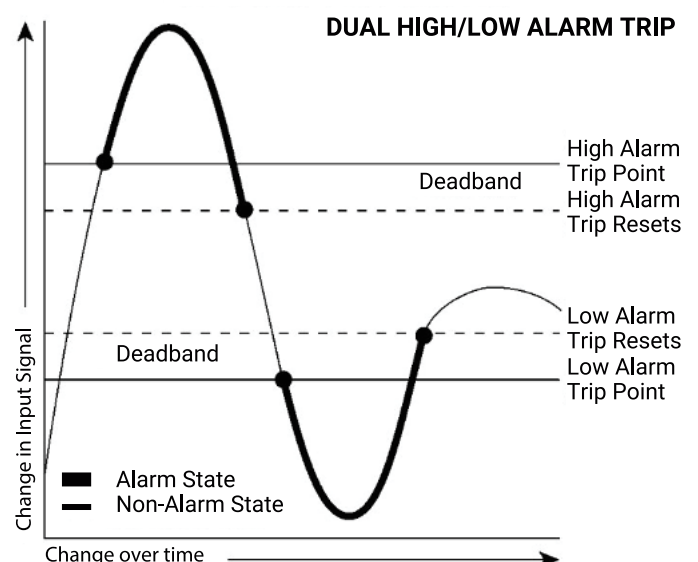





# Indicators Offerings



PHI-22-XP



409-W



40005E



409-6IN



LC5296H



1008S



406L



LPI-1-XP



CDU



FDU



**Display:** Enhanced visibility, 6" bright display suitable for outdoor application

**Accuracy:** High accuracy with up to 5 digit option



**TPS:** Inbuilt power supply for transmitter, saves external power supply









**Communication:** Isolated Re-transmission & RS-485 Modbus communication



**Configurable:** Input & output signal type is configurable, helps reduce inventory



# Technical Specifications- Indicators

		409-4IN	409-6IN	408-2IN	LPI-1-LED	LPI-1-XP	LC5296H	406	406L
									
Mounting		Rack / Panel / Wall	Wall	Panel	Panel/ Wall	Wall / Pipe	Panel	Panel	Panel
Panel Cut Out (HXW)		444 (+0.8) x175 (+0.8)	-	92 x 188	-	-	45 x 92	45 x 92	45 x 92
Dimension (HXWXD)		IP 20: 440 x 175 x 70 IP 65: 500 x 300 x120	405 x 250 x 90 (With Clamp)	96 x 192 x 70	Panel: 96 x 48 x 68 mm Wall: 122 x 88 x44 mm	112 x 115 x146	48 x 96 x 85	48 x 96 x 85	48 x 96 x 85
Display Range		-1999 to 9999	-1999 to 9999	-1999 to 9999	-1999 to 9999	-1999 to 9999	-1999 to 9999	-1999 to 9999	-1999 to 9999
Character Height		4"	6"	2"	0.56"	0.56"	0.56"/ 0.8"	0.56"	0.56"
Accuracy		±0.1% of FS ± 1digit	±0.1% of FS ± 1digit	TC, RTD : ±0.25% of FS ± 1° C Current, Voltage : ±0.1% of FS ± 1digit	±0.1% of FS ± 1digit	±0.1% of FS ± 1digit	TC, RTD : ±0.25% of FS ± 1° C Current, Voltage : ±0.1% of FS ± 1 digit	TC, RTD : ±0.25% of FS ± 1° C Current, Voltage : ±0.1% of FS ± 1digit	± 0.1% of F.S ± 1 count
Input		Thermocouple (E, J, K, T, B, R, S), RTD (Pt100), Current, Voltage, Resistance	Thermocouple (E, J, K, T, B, R, S), RTD (Pt100), Current, Voltage, Resistance	Thermocouple (J, K, T, B, R, S), RTD (Pt100), Current, Voltage	4-20mA	4-20mA	Thermocouple (J, K, T, R, S), RTD (Pt100), Current, Voltage	Thermocouple (J, K, T, R, S), RTD (Pt100), Current, Voltage	4-20mA 0-20mA 1-5V 0-5V 0-10V
Output	Serial Input	●	●	X	-	-	X	-	-
	DI	X	X	X	X	X	X	X	X
	Re-transmission Output	1	1	Upto 2*	-	-	1	X	X
	Alarm	2	2	2	-	-	2	X	X
	LPS	●	●	●	-	-	●	●	X
Communication	RS-485	●	●	●	-	-	●	X	X
Power Supply	85-265VAC / 100-300 VDC	●	●	●	-	-	●	●	●
	18-36 VDC	-	-	-	-	-	●	●	●
	Loop Powered	-	-	-	●	●	-	-	-

\* For more details, refer Product Catalogue





# pH Indicator & Load Cell Indicator

## PHI-22-XP Flame Proof pH Indicator



PHI-22-XP

- 5 Point calibration
- Slope/offset adjustment
- Built-in-diagnostics
- Electrode performance indicator
- Auto/manual temperature compensation
- Certified for use in zone 1 of gas group I, IIA & IIB hazardous areas, optionally IIC certified compact flame proof housing
- Re-transmission signal and RS-485 can be opted for interfacing with PLC/ SCADA/ Recorder etc.

## 409-W Load Cell Indicator



409-W

- Selectable load cell input ranges
- 5 Digit 0.56" LED display
- Local cell excitation voltage selectable from 5 to 15V DC (Factory set)
- Tare adjustment through keypad/DI
- User selectable gross and net values
- RS-485 interface (Optional) for connecting PLC/DCS

## Dynamic Weighing Indicator

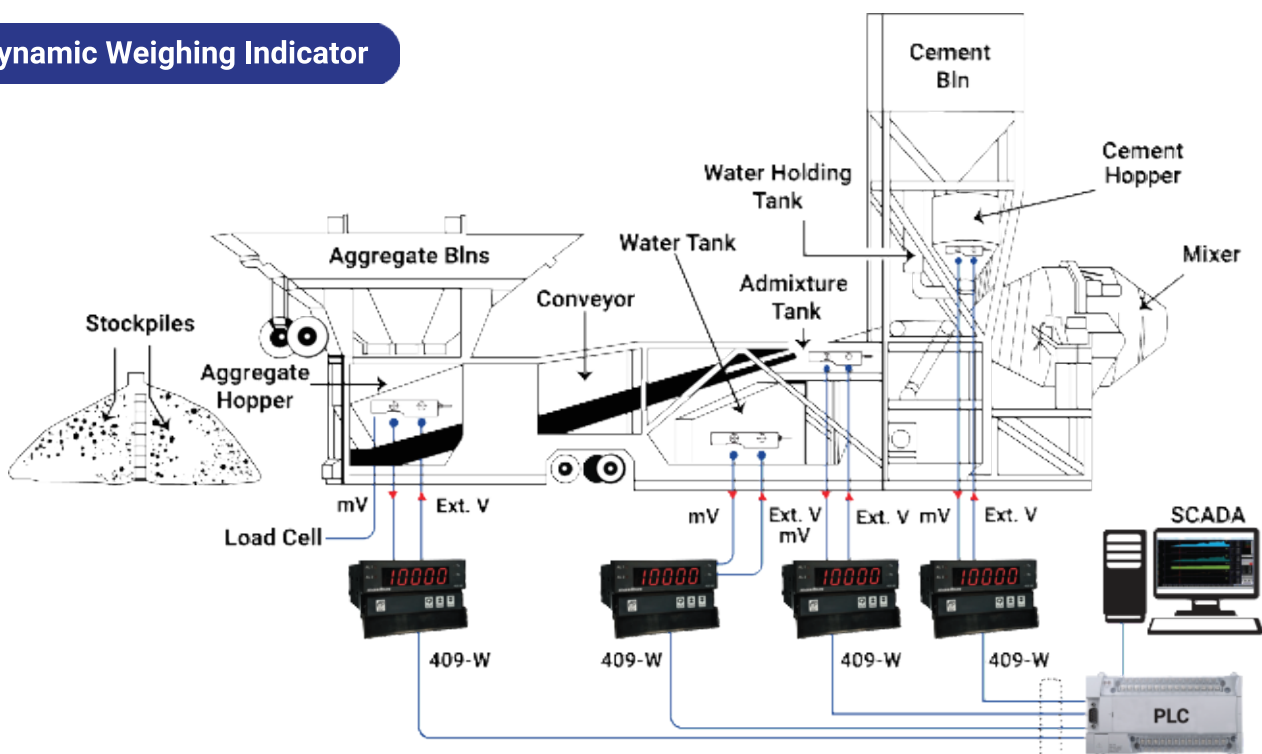

0 to 10/4 to 20 mA/ Modbus



# Large Display Indicators

## 409-4IN / 409-6IN Large Display Indicators



409-4IN



409-4IN



409-6IN

- 409-4IN: 4" (100mm) Large Red LED Display
- 409-6IN: 6" (150mm) Large P10 based Red LED
- Measure 21 selectable input types (TC, RTD, mV, mA, V,  $\Omega$ )
- Transmitter power supply
- RS-485 serial communication (Optional)
- PV write facility via serial input
- Programmable Re-transmission output (Optional)
- Two programmable alarm outputs (Optional)
- Serial RS-485 Input (Modbus Slave Read/Write)
- 409-6IN: High brightness for outdoor application

## Digital Peak Hold Temperature Indicator

Forging Industry



Billet Heating Furnace



Pyrometer



4-20mA

HMI



RS-485

Relay  
Accept/Reject Billet



409-4IN





## Process Indicators

### LPI-1/LPI-1-XP- Loop Power Indicator & Ex-Proof Loop Powered Indicators



LPI-1



LPI-1

- 4-Digit LED display
- Accuracy 0.1% of FS
- Loop powered with low voltage drop
- Reverse scaling for indication range
- Square root extraction
- Easy configuration with pushbuttons
- Compact and IP65 front/housing
- Panel and wall mount or pipe mount for Ex-Proof options
- IIA/IIB, Zone 1 & 2 PESO certification on FLP versions



LPI-1-XP

### LC5296H / 408-M / 406 / 406L- Process Indicator (Relay Optional) & 40005E Bar Graph indicator



LC5296H



408-M



406



406L



40005E

- Retransmission (Field Programmable) and/or RS-485 add-on options
  - One model for many applications, interface with PLC, SCADA, IIoT and other platforms
- Two relay output option
  - For alarm and ON/OFF control
- TPS with current limit
  - Inbuilt power supply for transmitter, saves external power supply
- Input High/Low Programmable
  - Settable input signal from 0 to 20mA/0 to 10V DC to connect non std. output type sensor



# Flow Rate Indicator & Totalizer

1008S/1006H Flow Rate Indicator & Totalizer | 1008S-XP:- Ex-Proof Flow Rate Indicator & Totalizer



1008S-XP



1006H



1008S

- Accurate, Pressure & Temperature compensation, fast sampling and totalize with precision even fast changing flow rates
- 4 Relay output - 2 Relay for flow rate alarm & 2 relay for pre/final batch total
- 4-Digital I/P- Batch start/stop, batch / integration total zero
- Mass flow measurement with additional Pressure and Temperature I/P
- Gas/ liquid flow measurement- Superheated steam flow measurement & Saturated steam flow measurement
- Five segment linearization on flow Input for nonlinear type of input
- Retransmission output easy interface with PLC / DCS / SCADA systems
  - Ex-Proof enclosure, touch sensitive keys operation, full operation and programmable without opening in a compact size

## Mass Flow Measurement

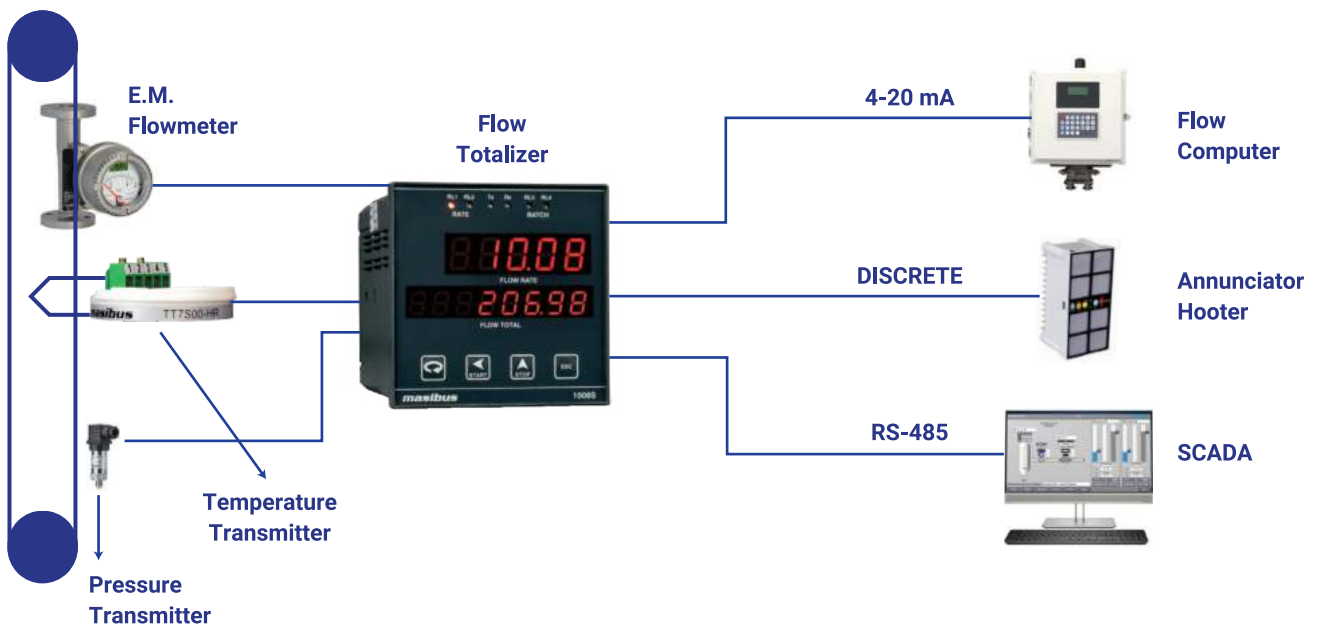



# Clean Room Indicator & Filter Display Unit

## Clean Room Display Unit



CDU

- Variant for combination of Temperature, Humidity and DP Indication
- Variant of internal sensor, external sensor, wireless sensor, analog sensor
- Backed by Masibus 21CFR Software with Auto Backfilling via DNP 3.0 avoiding data loss
- 3.5" TFT touchscreen LCD variant
- Soft Input for AHU status
- Digital input for door open/close
- Ex-Proof enclosure- Touch sensitive keys operation

## Filter Display Unit



FDU

- 3 Channel differential pressure Indicator
  - PRE/FINE/HEPA filter monitoring of AHU
- Software programmable filter ranges
- 3 Programmable Hi/Lo alarms with audio/visual annunciation
- RS-485 Modbus RTU communication for PLC, SCADA, etc.
- Digital I/P for AHU OFF/TRIP status with LED indication
- Soft status available in Modbus

## Environment Monitoring System

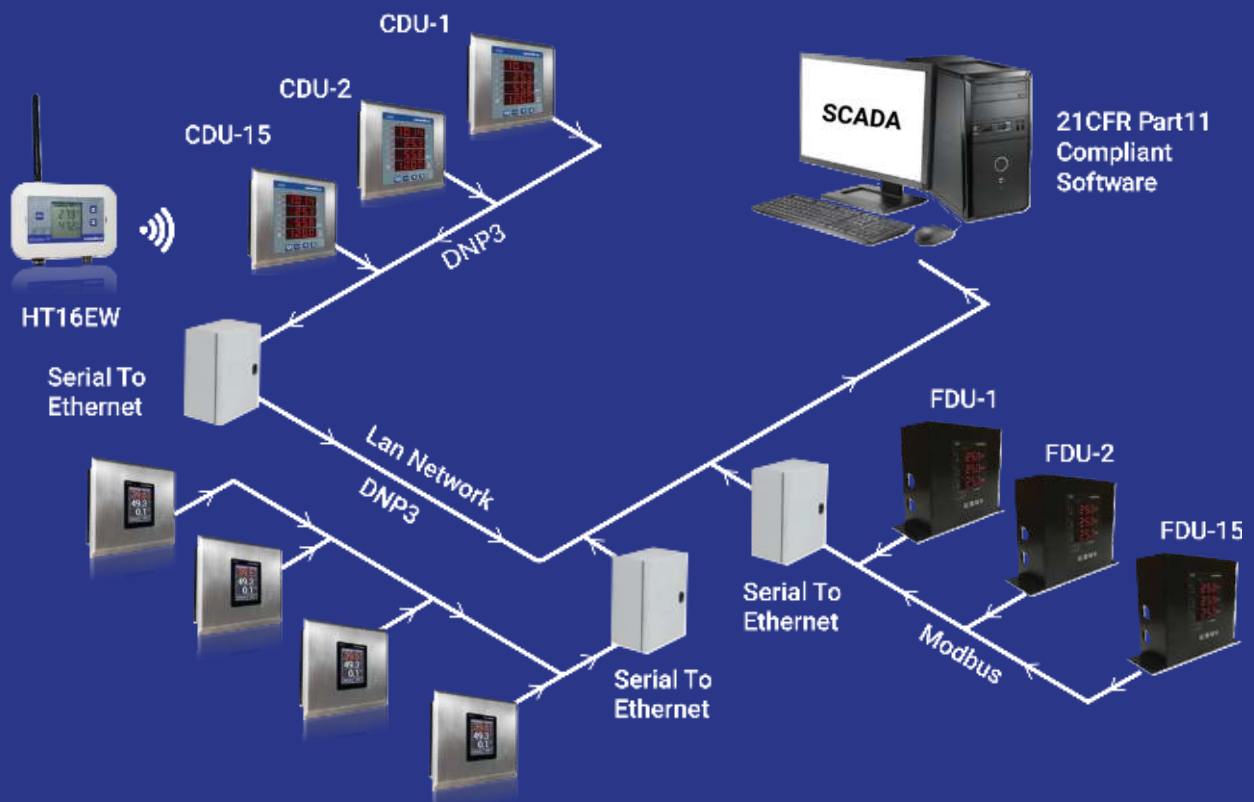



## HMI in Reactor Automation

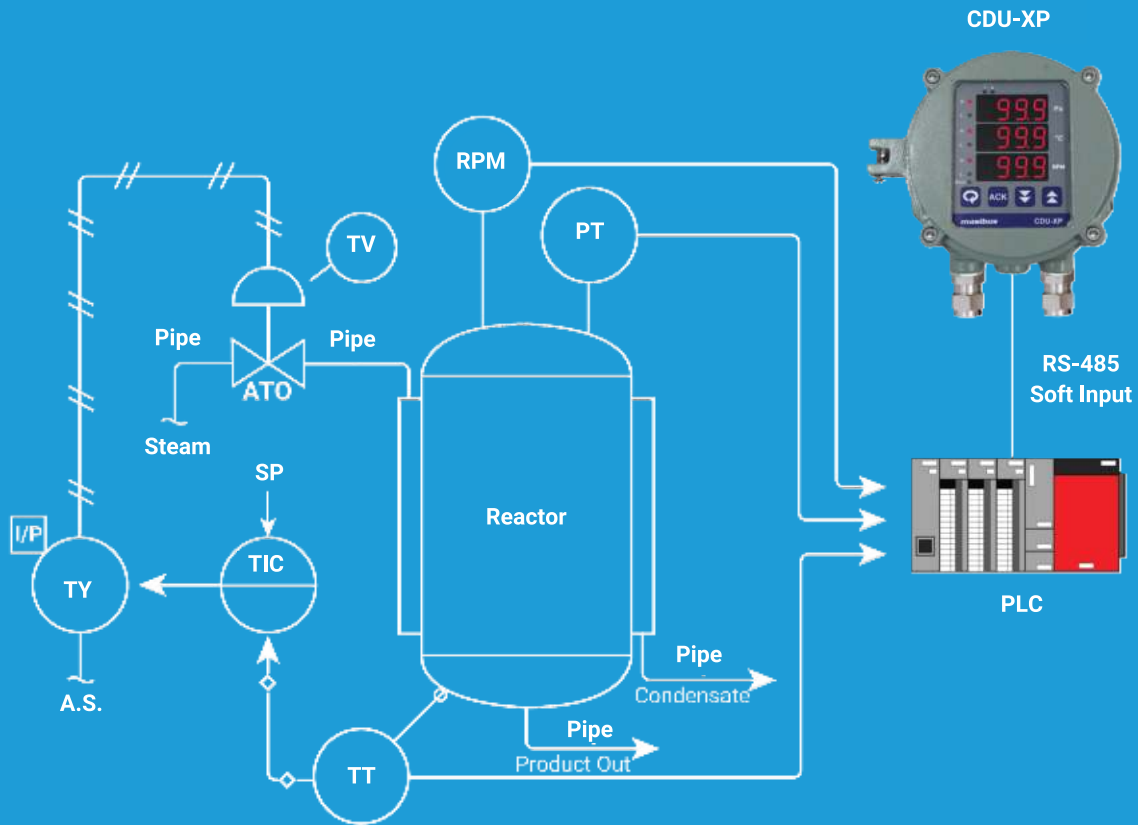

## AHU Monitoring

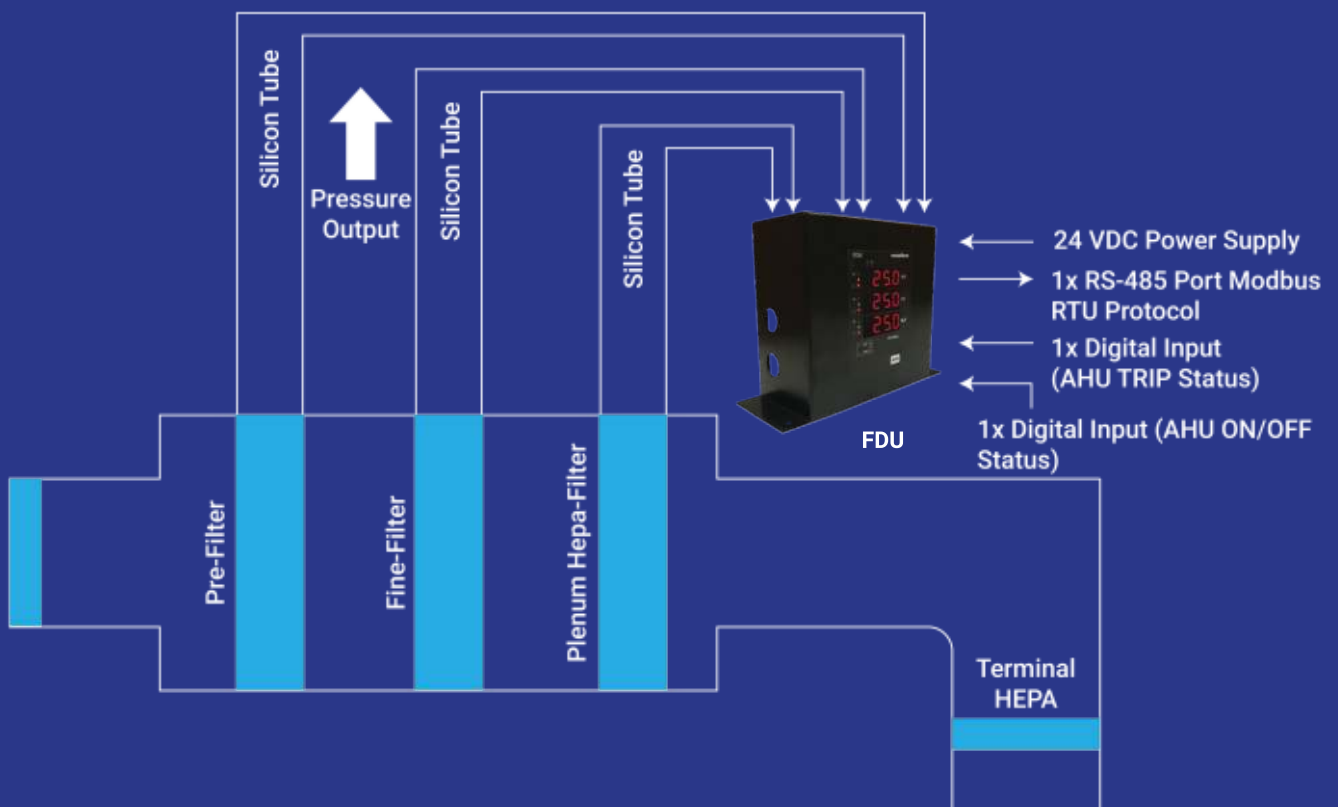

# **masibus**<sup>®</sup>

A Sonepar Company

## Masibus Automation And Instrumentation Pvt. Ltd.

### **Gandhinagar**

**Address:** B-30, G.I.D.C. Electronic Estate,  
Sector - 25, Gandhinagar - 382 024,  
Gujarat, India  
**E-mail:** sales@masibus.com  
**Ph. No.:** +91 9662042824

### **Goa**

**Address:** C-6, Phase 1-A, Verna Industrial  
Estate, Verna, Salcette - 403722,  
Goa, India  
**E-mail:** sales@masibus.com  
**Ph. No.:** +91 9822135796

### **Sharjah**

**Address:** A2-102, SAIF Zone, PO Box  
120145 Sharjah, UAE  
**E-mail:** sharjahall@masibus.com  
**Ph. No.:** +971 65574650

### **Bengaluru**

**E-mail:** sales@masibus.com  
**Ph. No.:** +91 8732971943

### **Chennai**

**E-mail:** sales@masibus.com  
**Ph. No.:** +91 9725154195

### **Delhi**

**E-mail:** sales@masibus.com  
**Ph. No.:** +91 9909949742

### **Hyderabad**

**E-mail:** sales@masibus.com  
**Ph. No.:** +91 9909949062

### **Kolkata**

**E-mail:** sales@masibus.com  
**Ph. No.:** +91 9512003359

### **Mumbai**

**E-mail:** sales@masibus.com  
**Ph. No.:** +91 9689937234

### **Pune**

**E-mail:** sales@masibus.com  
**Ph. No.:** +91 9689937234

**E-mail:** sales@masibus.com  
**Website:** www.masibus.com

Sales Service: TOLL FREE (India)

**1-800-233-2273**

## Sonepar India Pvt. Ltd.

### **Gurgaon**

**Address:** Plot No. 229/239, Village -  
Kherki Daula, Sector 76, Gurugram,  
Haryana, 122004, India

### **Kolkata**

**Address:** 503, Block 4B, Ecospace  
Business Park, Newtown, Rajarhat,  
Kolkata, West Bengal, 700160, India

### **Chennai**

**Address:** Plot No. 1, Gokul Garden,  
Melnallathur, Thiruvallur, Chennai,  
Tamil Nadu, 602002, India

### **Aurangabad**

**Address:** FP-42, Five Star Industrial Area,  
Shendra MIDC, Aurangabad,  
Maharashtra, 431201, India

### **Panchkula**

**Address:** Plot No. 263, Industrial Area,  
Phase-II, Panchkula, Haryana,  
134113, India

### **Bhubaneswar**

**Address:** Plot No. 443, 1st Floor,  
Saheed Nagar, Bhubaneswar,  
Odisha, 751007, India

**E-mail:** communications@soneparindia.com  
**Website:** www.soneparindia.com